

REVISION DATA				
SYM	ECN	DESCRIPTION	DATE	APPROVED

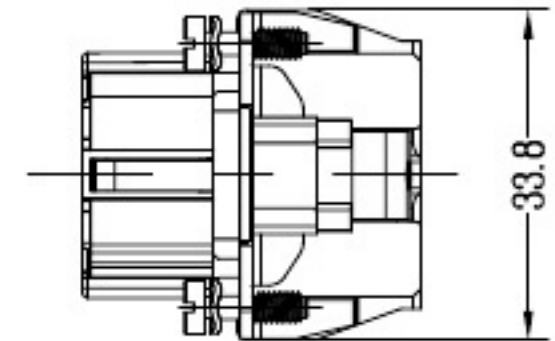

contact arrangement

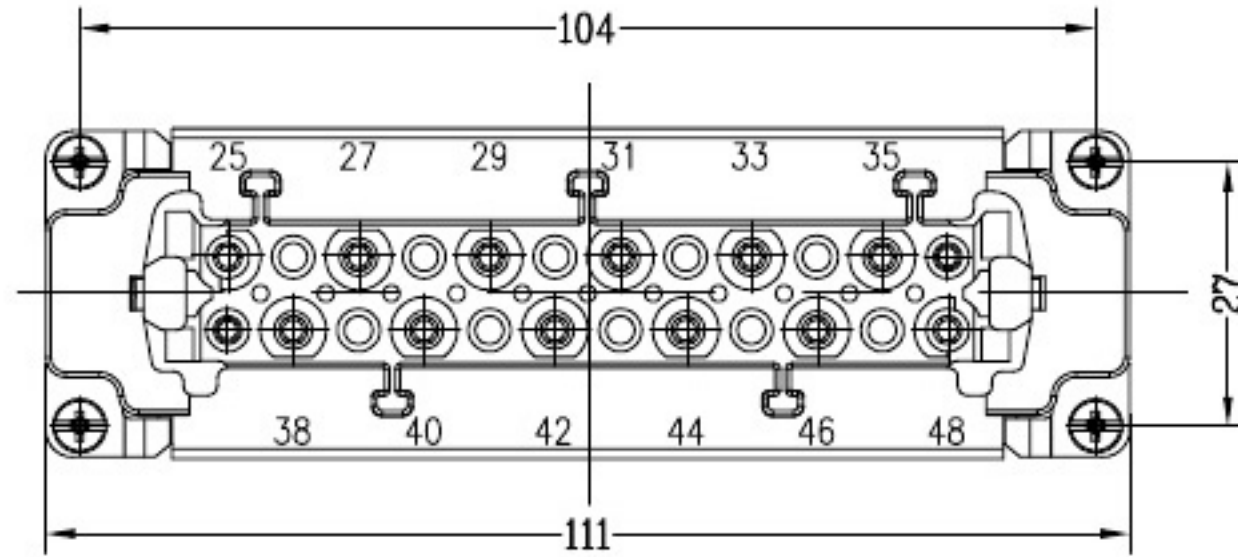
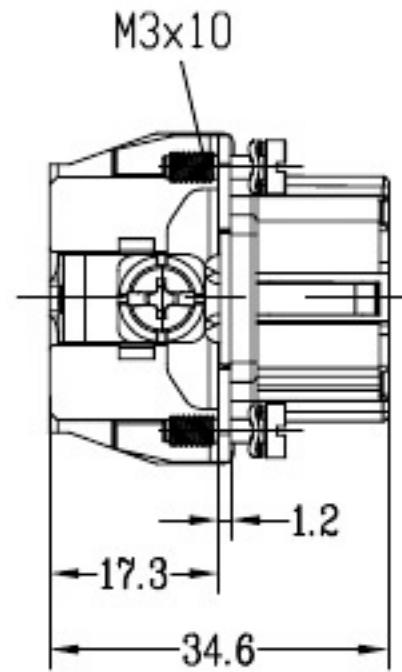
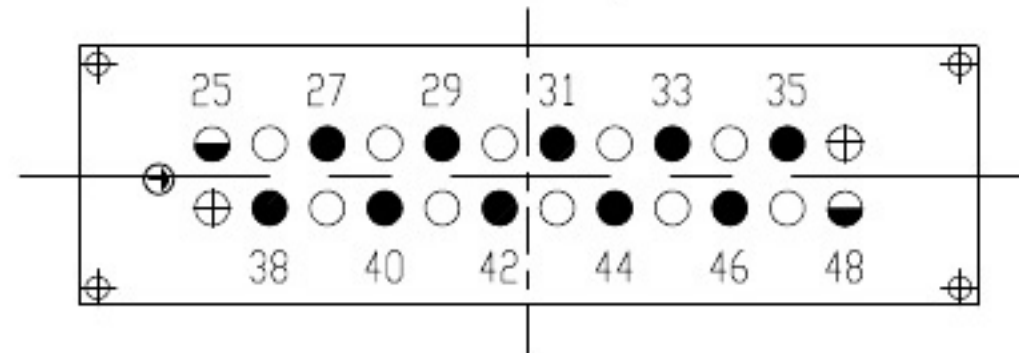

- Working contacts
- ◐ Relay contacts
- ⊕ Fool proof needle
- Without contacts

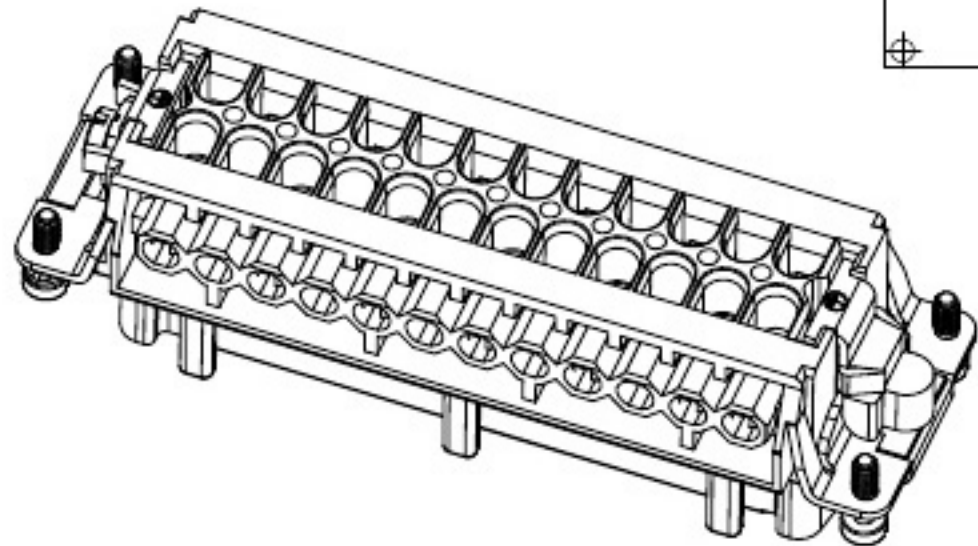

	SIGNATURE	DATE	Units	mm	 宁波欧科瑞连接器有限公司 NINGBO OKERUI CONNECTOR CO.,LTD.	
DRAW			Size	A4	PART NAME	HZW-HVE-020-F (11-20)
DESIGN			Scale	1:1	Drawing NO.	61 276 020 152 REV
CHECK			Sheet	1/1	File path	OKR.VEP.020F A0
APPROVE			Proj.	