

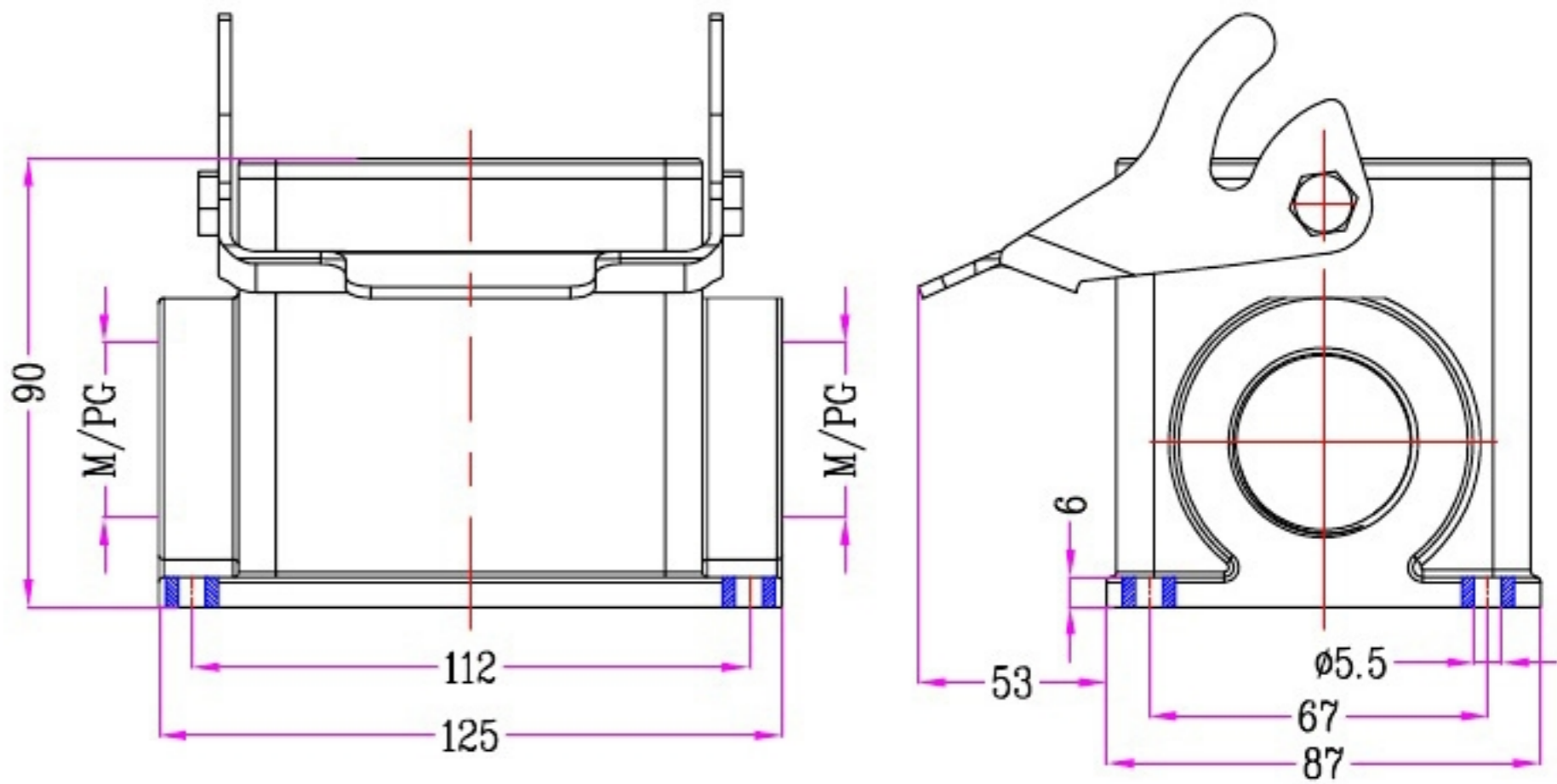

1	2	3	4	5	6	7	8
Identification	Type name	Part number	Thread(M/PG)	Lever type	Your Choice	REVISION DATA	
Housings Surface mounting	HZW-HV32B-SG-1PL-M32	92 524 032 132	M32	Metal		SYM	ECN
	HZW-HV32B-SG-1PL-2M32	92 524 032 232	2M32	Metal		DESCRIPTION	DATE
	HZW-HV32B-SG-1PL-M40	92 524 032 140	M40	Metal		APPROVED	
	HZW-HV32B-SG-1PL-2M40	92 524 032 240	2M40	Metal			
	HZW-HV32B-SG-1PL-PG29	92 524 032 129	PG29	Metal			
	HZW-HV32B-SG-1PL-2PG29	92 524 032 229	2PG29	Metal			
	HZW-HV32B-SG-1PL-PG36	92 524 032 136	PG36	Metal			
	HZW-HV32B-SG-1PL-2PG36	92 524 032 236	2PG36	Metal			



	SIGNATURE	DATE	Units	mm	 宁波欧科瑞连接器有限公司 NINGBO OKERUI CONNECTOR CO.,LTD.		
DRAW			Size	A4	TYPE NAME	HZW-HV32B-SG-1PL-M/PG	
DESIGN			Scale		Part number	92 524 032 XXX	REV
CHECK			Sheet	1/1	File path	OKR. 32V. H32VL	A0
APPROVE			Proj.	