

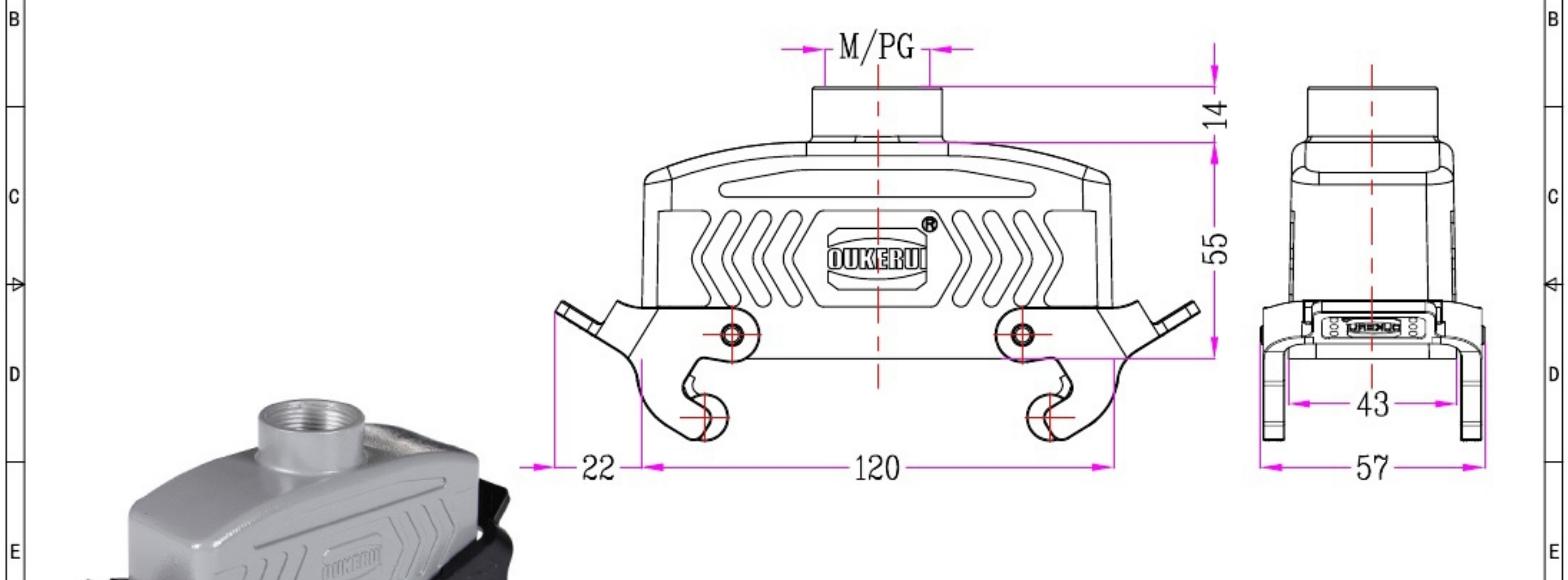

1	2	3	4	5	6	7	8
Identification	Type name	Part number	Thread(M/PG)	Lever type	Your Choice	REVISION DATA	
Hoods Top entry	HZW-HV24B-TK-2PL/R-M25	93 504 024 025	M25	Plastic and Metal		SYM	ECN
	HZW-HV24B-TK-2PL/R-M32	93 504 024 032	M32	Plastic and Metal		DESCRIPTION	DATE
	HZW-HV24B-TK-2PL/R-PG21	93 504 024 021	PG21	Plastic and Metal		APPROVED	
	HZW-HV24B-TK-2PL/M-M25	93 504 024 025	M25	Metal			
	HZW-HV24B-TK-2PL/M-M32	93 504 024 032	M32	Metal			
	HZW-HV24B-TK-2PL/M-PG21	93 504 024 021	PG21	Metal			



	SIGNATURE	DATE	Units	mm	 宁波欧科瑞连接器有限公司 NINGBO OKERUI CONNECTOR CO.,LTD.		
DRAW			Size	A4	TYPE NAME	HZW-HV24B-TK-2PL/RM-M/PG	
DESIGN			Scale		Part number	93 504 024 XXX	REV
CHECK			Sheet	1/1	File path	OKR. 24V. H24VM	A0
APPROVE			Proj.	