

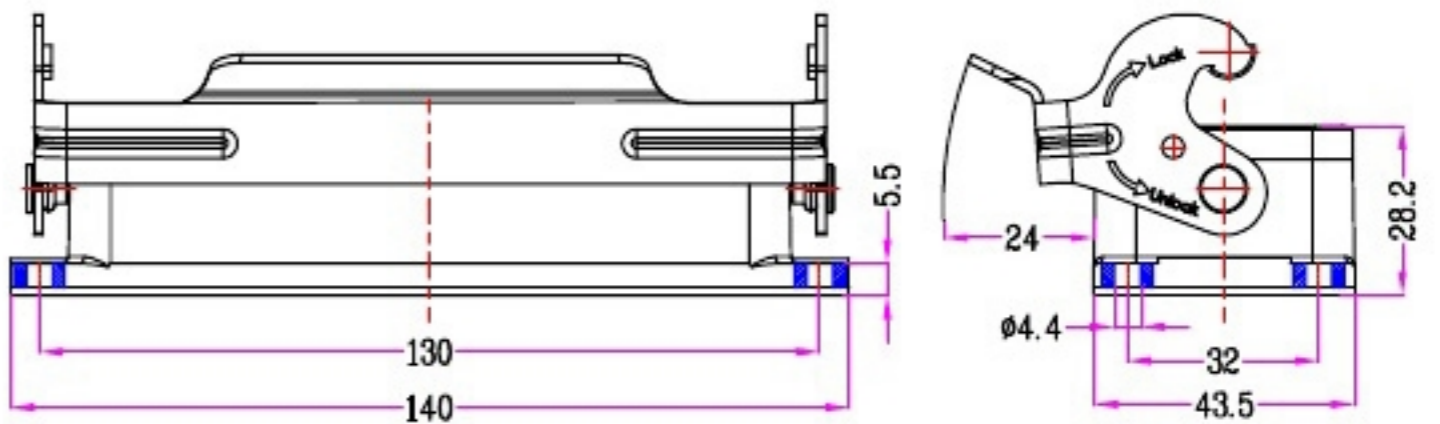

1	2	3	4	5
Identification	Type name	Part number	Thread(M/PG)	Lever type
Housings Bulkhead mounting	HZW-HV24B-ST-1PL	91 504 024 201		Metal
				Your Choice

REVISION DATA				
SYM	ECN	DESCRIPTION	DATE	APPROVED

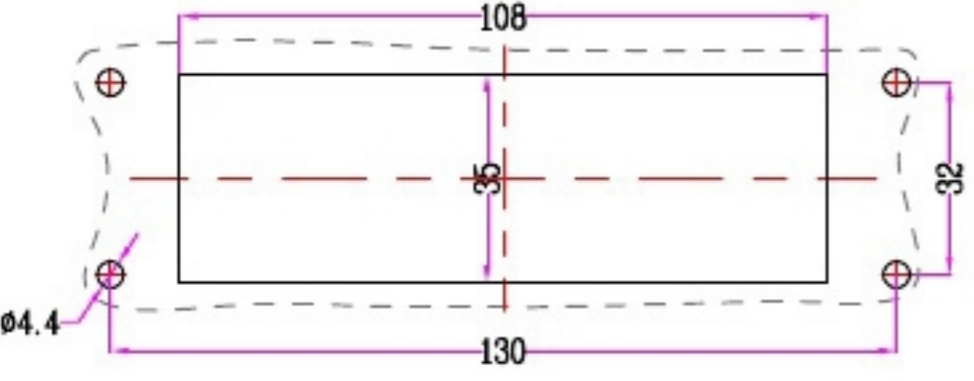

Bulkhead mounting
Panel cut out

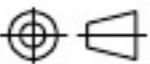

	SIGNATURE	DATE	Units	mm	 宁波欧科瑞连接器有限公司 NINGBO OKERUI CONNECTOR CO.,LTD.		
DRAW			Size	A4			
DESIGN			Scale		TYPE NAME	HZW-HV24B-ST-1PL	
CHECK			Sheet	1/1	Part number	91 504 024 201	REV
APPROVE			Proj.		File path	OKR. 24V. H24VL	A0