

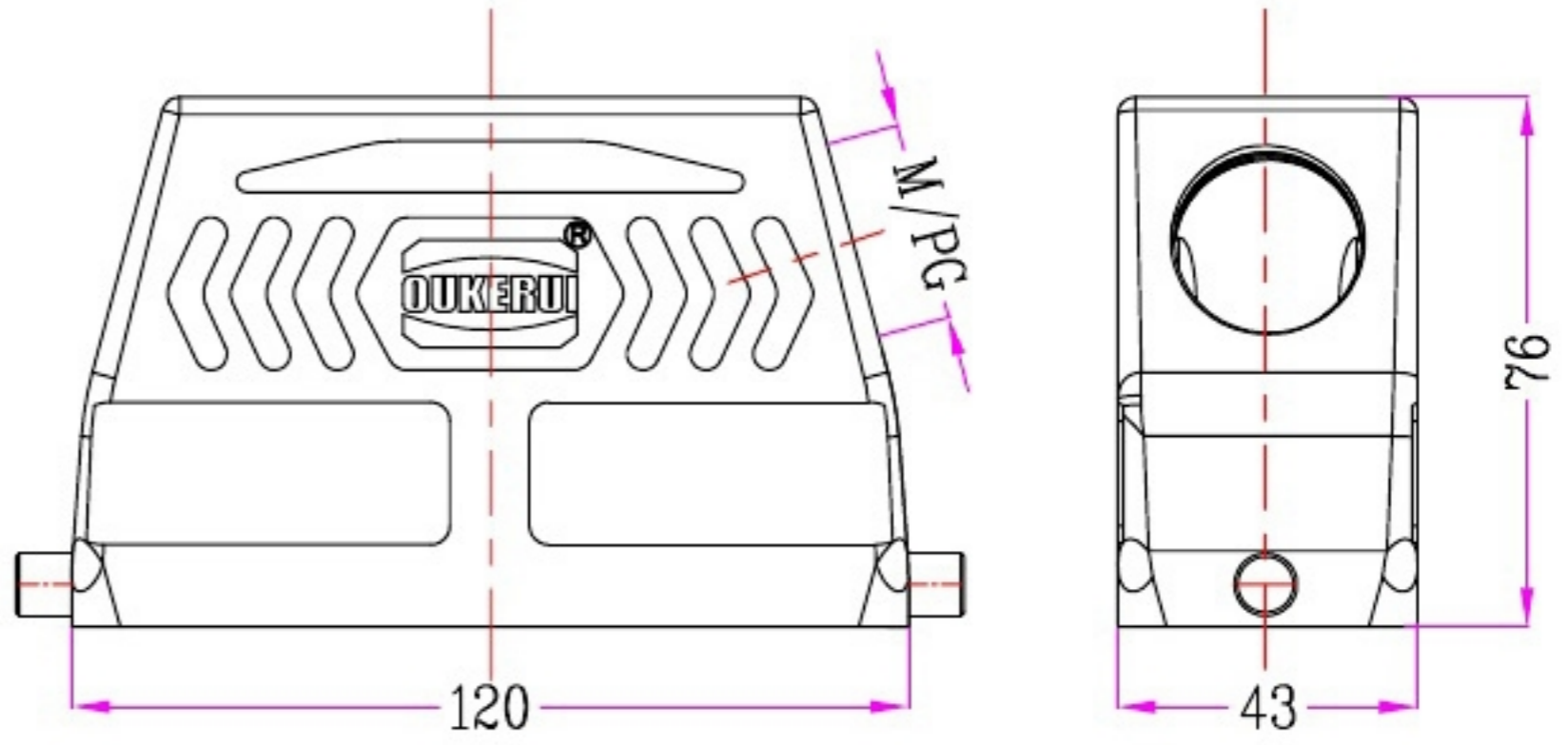

1	2		3	4	5	6		7	8	
Identification	Type name		Part number	Thread(M/PG)	Your Choice	REVISION DATA				
Hoods	HZW-HV24B-SKH-2g-M32		92 514 024 132	M32		SYM	ECN	DESCRIPTION	DATE	APPROVED
Side entry	HZW-HV24B-SKH-2g-M40		92 514 024 140	M40						
High structure	HZW-HV24B-SKH-2g-PG21		92 514 024 121	PG21						
	HZW-HV24B-SKH-2g-PG29		92 514 024 129	PG29						



	SIGNATURE	DATE	Units	mm	 宁波欧科瑞连接器有限公司 NINGBO OKERUI CONNECTOR CO.,LTD.	
DRAW			Size	A4	TYPE NAME HZW-HV24B-SKH-2g-M/PG	
DESIGN			Scale		Part number	92 514 024 XXX REV
CHECK			Sheet	1/1	File path	OKR. 24V. H24VM A0
APPROVE			Proj.	