

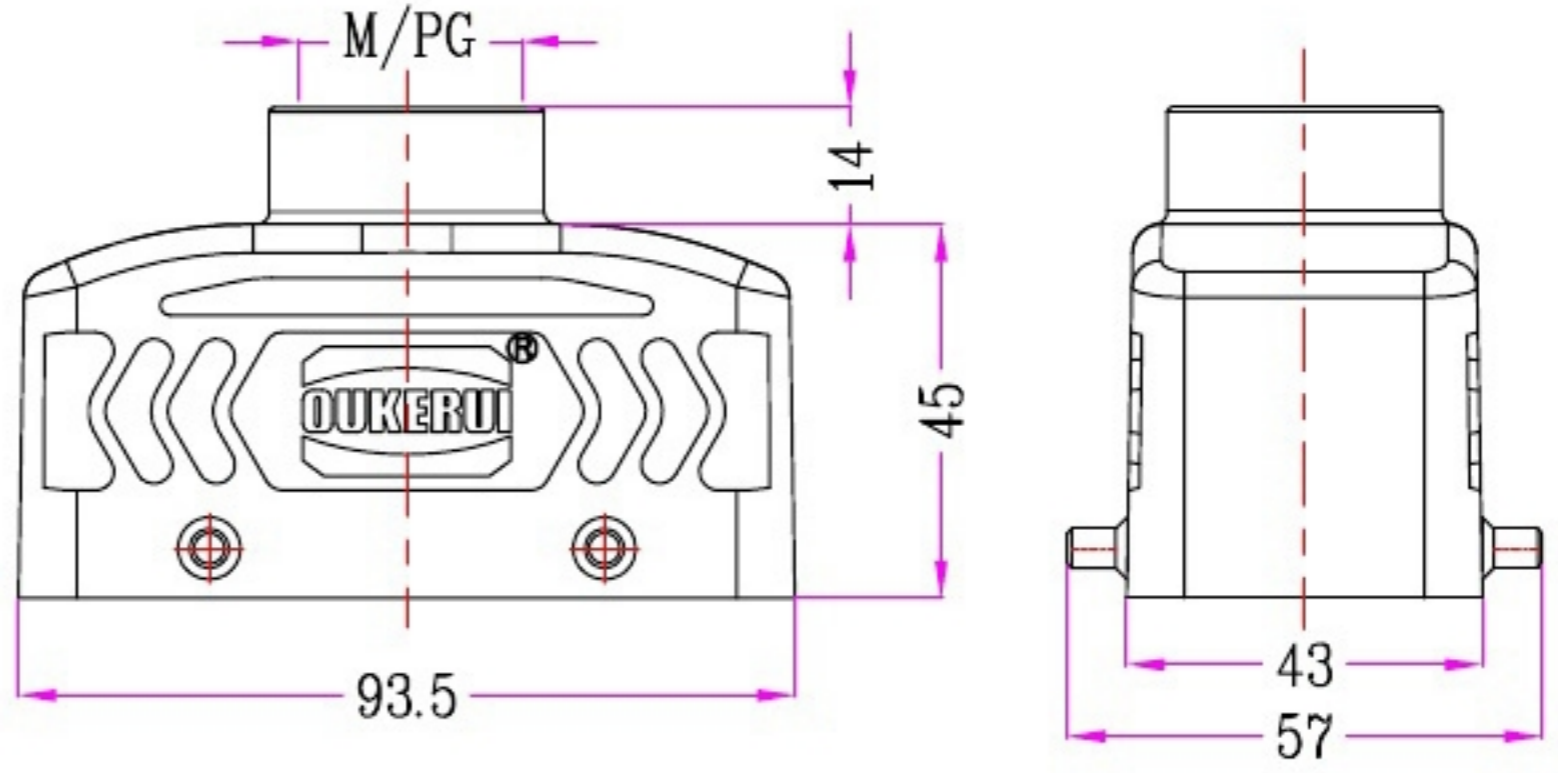

1	2	3	4	5	6	7	8		
Identification	Type name	Part number	Thread(M/PG)	Your Choice	REVISION DATA				
Hoods Top entry	HZW-HV16B-TK-4g-M25	91 503 016 025	M25		SYM	ECN	DESCRIPTION	DATE	APPROVED
	HZW-HV16B-TK-4g-M32	91 503 016 032	M32						
	HZW-HV16B-TK-4g-PG21	91 503 016 021	PG21						



	SIGNATURE	DATE	Units	mm	 宁波欧科瑞连接器有限公司 NINGBO OUKERUI CONNECTOR CO.,LTD.		
DRAW			Size	A4	TYPE NAME	HZW-HV16B-TK-4g-M/PG	
DESIGN			Scale		Part number	91 503 016 XXX	REV
CHECK			Sheet	1/1	File path	OKR.16V.H16VM	A0
APPROVE			Proj.	