

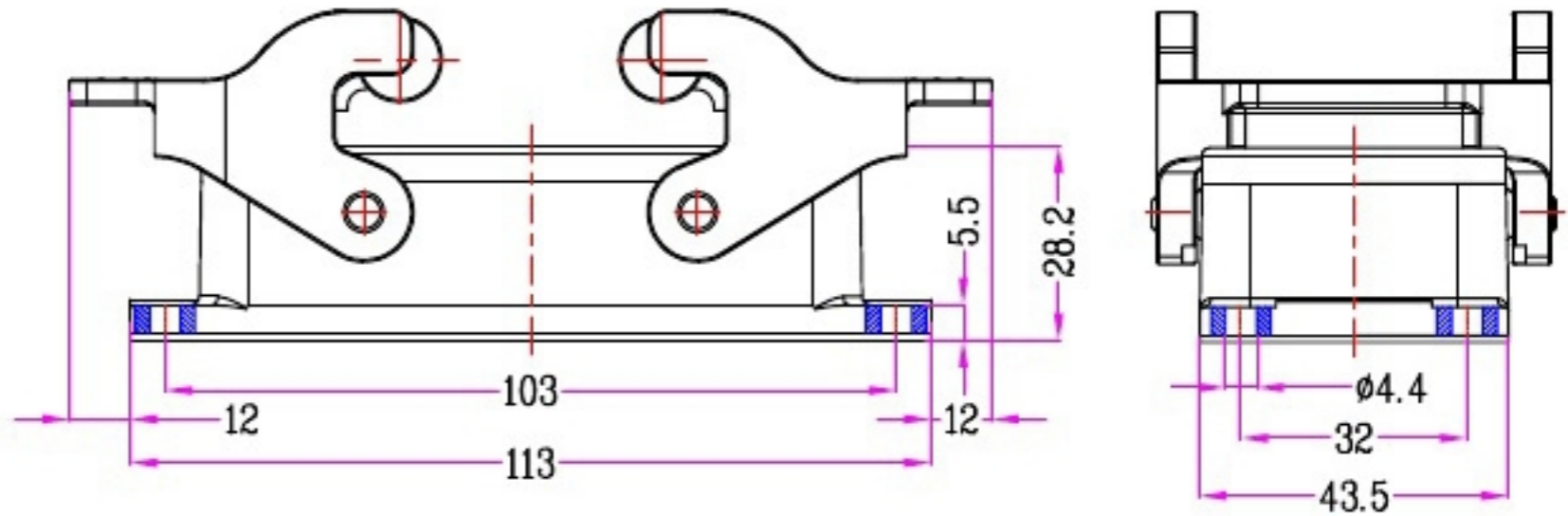

1	2	3	4	5
Identification	Type name	Part number	Thread(M/PG)	Lever type
Housings	HZW-HV16B-ST-2PL/R	91 503 016 101		Plastic and Metal
Bulkhead mounting	HZW-HV16B-ST-2PL/M	91 503 016 101		Metal

REVISION DATA				
SYM	ECN	DESCRIPTION	DATE	APPROVED

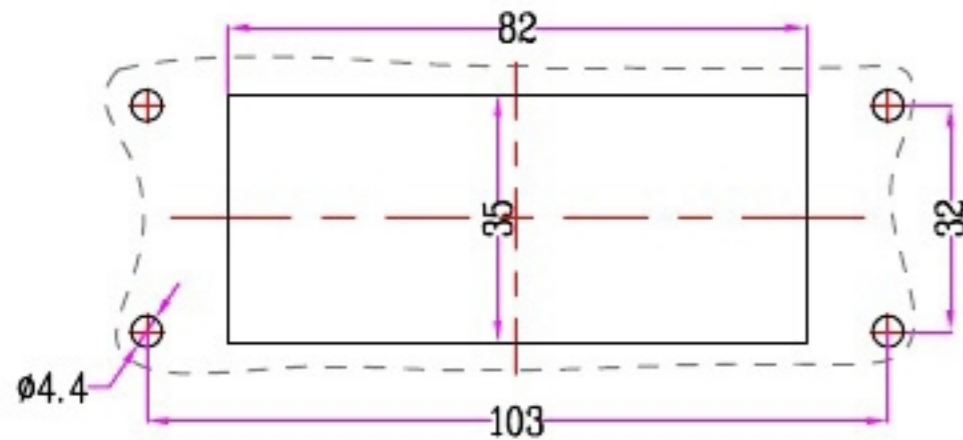

Bulkhead mounting
Panel cut out

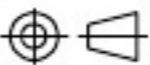

	SIGNATURE	DATE	Units	mm	 宁波欧科瑞连接器有限公司 NINGBO OKERUI CONNECTOR CO.,LTD.		
DRAW			Size	A4			
DESIGN			Scale		TYPE NAME	HZW-HV16B-ST-2PL/RM	
CHECK			Sheet	1/1	Part number	91 503 016 101	REV
APPROVE			Proj.		File path	OKR.16V.H16VL	A0