

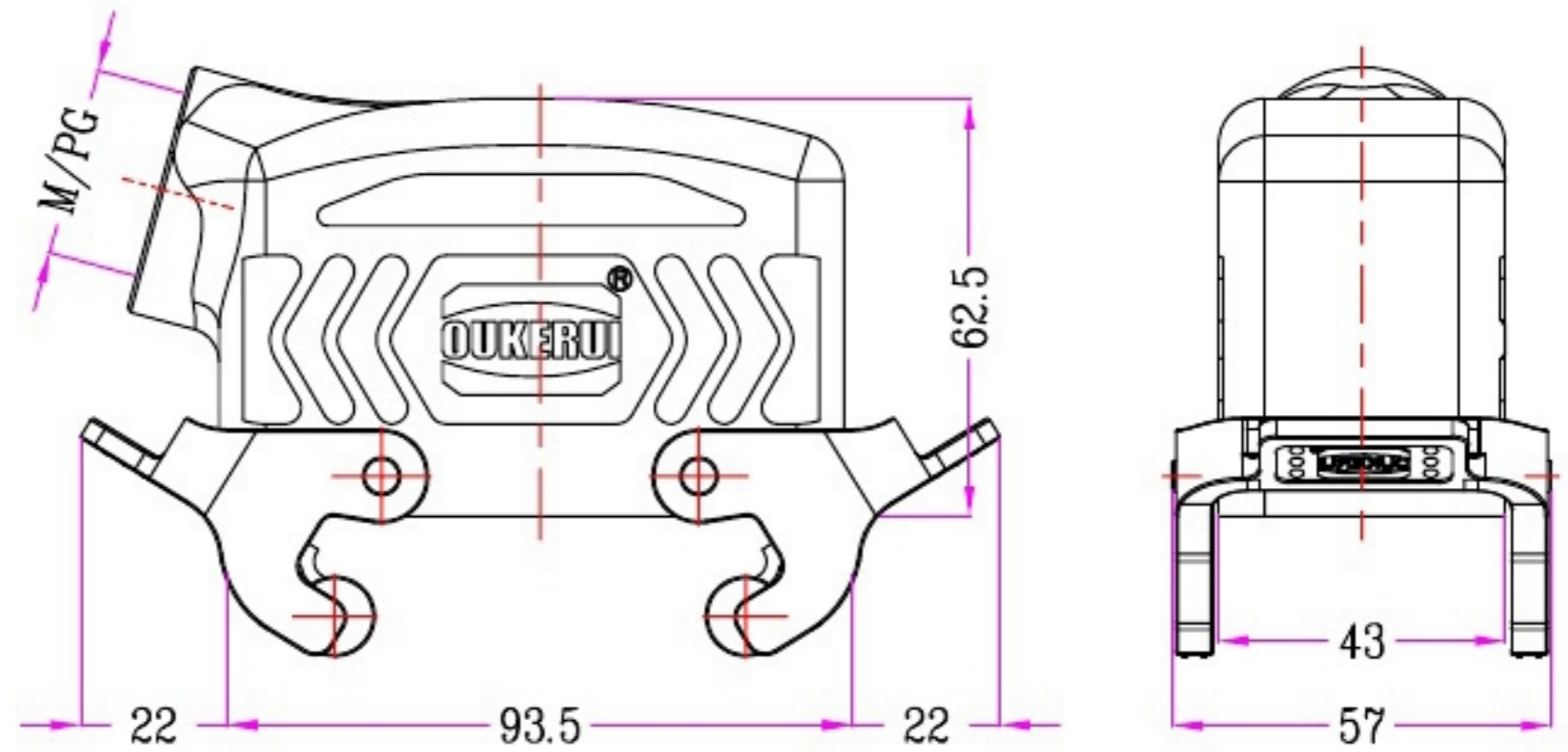

1	2	3	4	5	6	7	8		
Identification	Type name	Part number	Thread(M/PG)	Lever type	REVISION DATA			Your Choice	
Hoods Side entry	HZW-HV16B-SK-2PL/R-M25	93 513 016 025	M25	Plastic and Metal	SYM	ECN	DESCRIPTION	DATE	APPROVED
	HZW-HV16B-SK-2PL/R-M32	93 513 016 032	M32	Plastic and Metal					
	HZW-HV16B-SK-2PL/R-PG21	93 513 016 021	PG21	Plastic and Metal					
	HZW-HV16B-SK-2PL/M-M25	93 513 016 025	M25	Metal					
	HZW-HV16B-SK-2PL/M-M32	93 513 016 032	M32	Metal					
	HZW-HV16B-SK-2PL/M-PG21	93 513 016 021	PG21	Metal					



	SIGNATURE	DATE	Units	mm	 宁波欧科瑞连接器有限公司 NINGBO OKERUI CONNECTOR CO.,LTD.		
DRAW			Size	A4	TYPE NAME	HZW-HV16B-SK-2PL/RM-M/PG	
DESIGN			Scale		Part number	93 513 016 XXX	REV
CHECK			Sheet	1/1	File path	OKR.16V.H16VM	A0
APPROVE			Proj.	