

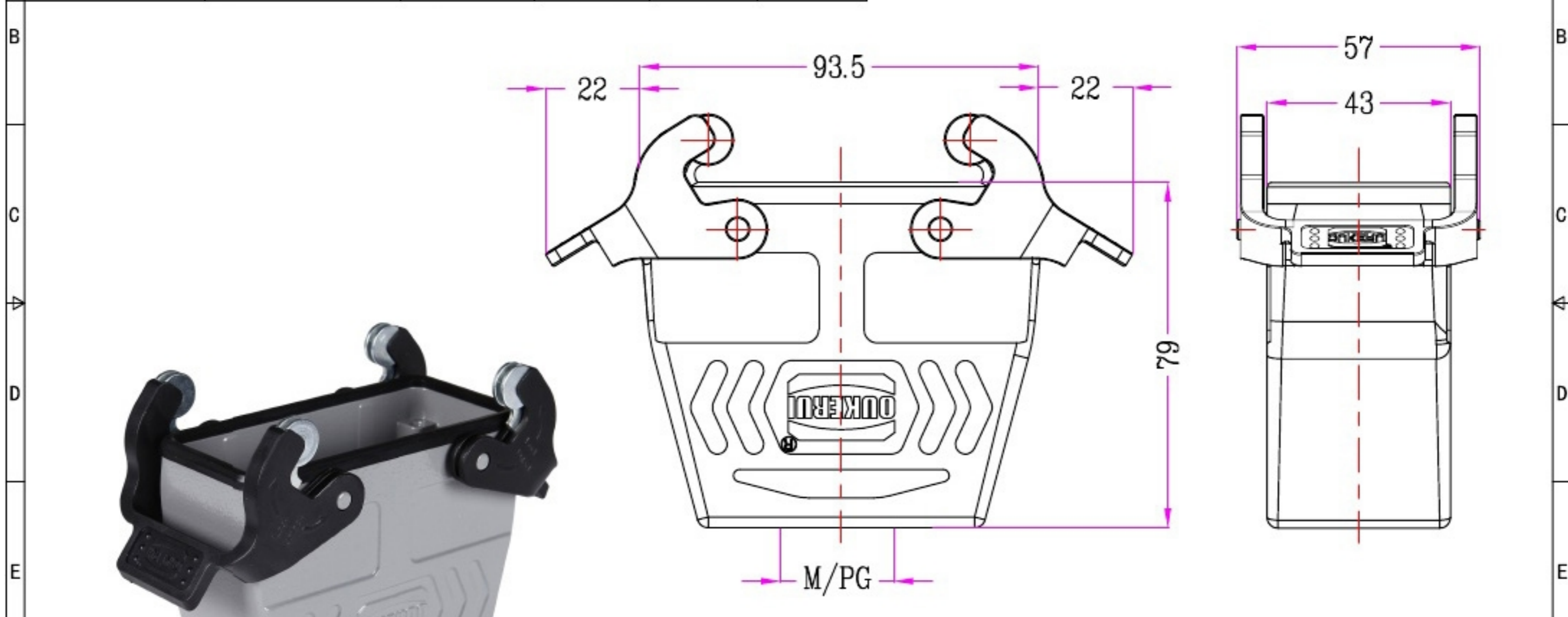

1	2	3	4	5	6	7	8			
Identification	Type name	Part number	Thread(M/PG)	Lever type	Your Choice	REVISION DATA				
Housings Cable to cable High structure	HZW-HV16B-DJKH-2PL/R-M32	96 513 016 132	M32	Plastic and Metal		SYM	ECN	DESCRIPTION	DATE	APPROVED
	HZW-HV16B-DJKH-2PL/R-M40	96 513 016 140	M40	Plastic and Metal						
	HZW-HV16B-DJKH-2PL/R-PG21	96 513 016 121	PG21	Plastic and Metal						
	HZW-HV16B-DJKH-2PL/R-PG29	96 513 016 129	PG29	Plastic and Metal						
	HZW-HV16B-DJKH-2PL/M-M32	96 513 016 132	M32	Metal						
	HZW-HV16B-DJKH-2PL/M-M40	96 513 016 140	M40	Metal						
	HZW-HV16B-DJKH-2PL/M-PG21	96 513 016 121	PG21	Metal						
	HZW-HV16B-DJKH-2PL/M-PG29	96 513 016 129	PG29	Metal						



	SIGNATURE	DATE	Units	mm	 宁波欧科瑞连接器有限公司 NINGBO OKERUI CONNECTOR CO.,LTD.	
DRAW			Size	A4	TYPE NAME HZW-HV16B-DJKH-2PL/RM-M/PG	
DESIGN			Scale		Part number	96 513 016 XXX REV
CHECK			Sheet	1/1	File path	OKR.16V.H16VM A0
APPROVE			Proj.	