

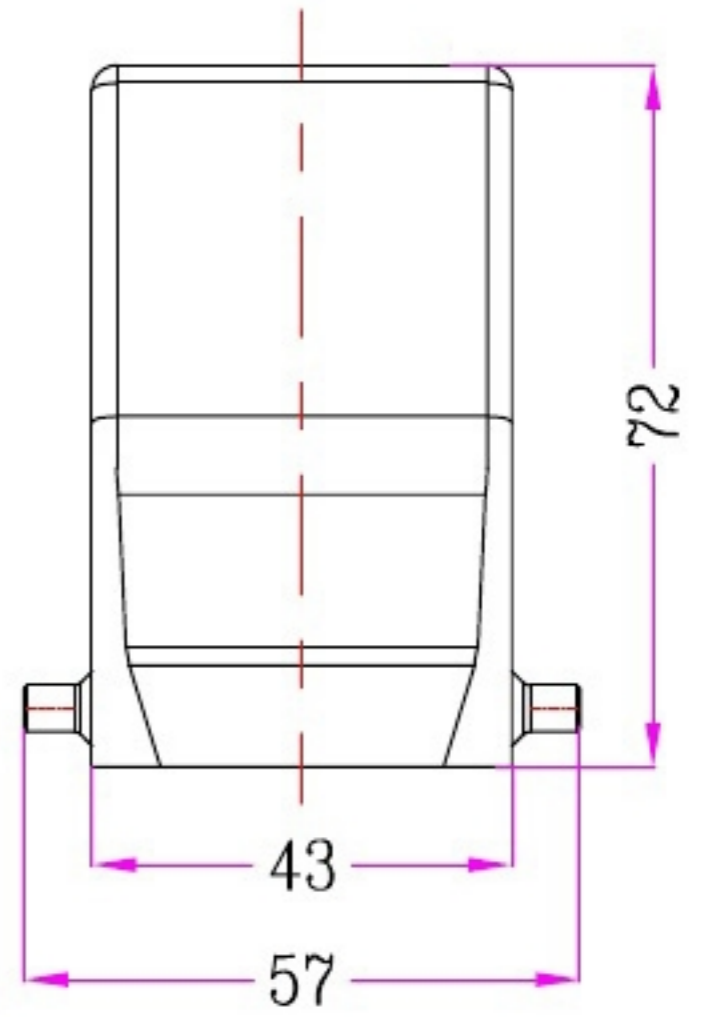

1	2		3	4	5	6		7	8	
Identification	Type name		Part number	Thread(M/PG)	Your Choice	REVISION DATA				
Hoods	HZW-HV10B-TKH-4g-M25		91 502 010 125	M25		SYM	ECN	DESCRIPTION	DATE	APPROVED
Top entry	HZW-HV10B-TKH-4g-M32		91 502 010 132	M32						
High structure	HZW-HV10B-TKH-4g-PG21		91 502 010 121	PG21						
	HZW-HV10B-TKH-4g-PG29		91 502 010 129	PG29						

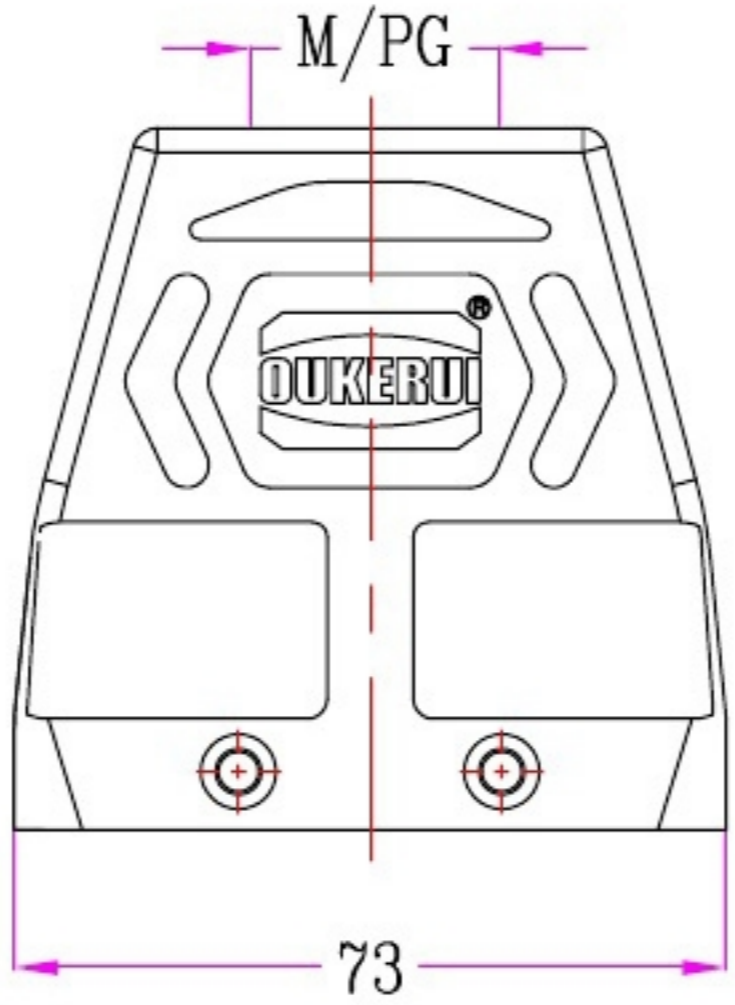

	SIGNATURE	DATE	Units	mm	 宁波欧科瑞连接器有限公司 NINGBO OKERUI CONNECTOR CO.,LTD.	
DRAW			Size	A4	TYPE NAME HZW-HV10B-TKH-4g-M/PG	
DESIGN			Scale		Part number	91 502 010 XXX REV
CHECK			Sheet	1/1	File path	OKR.10V.H10VM A0
APPROVE			Proj.	