

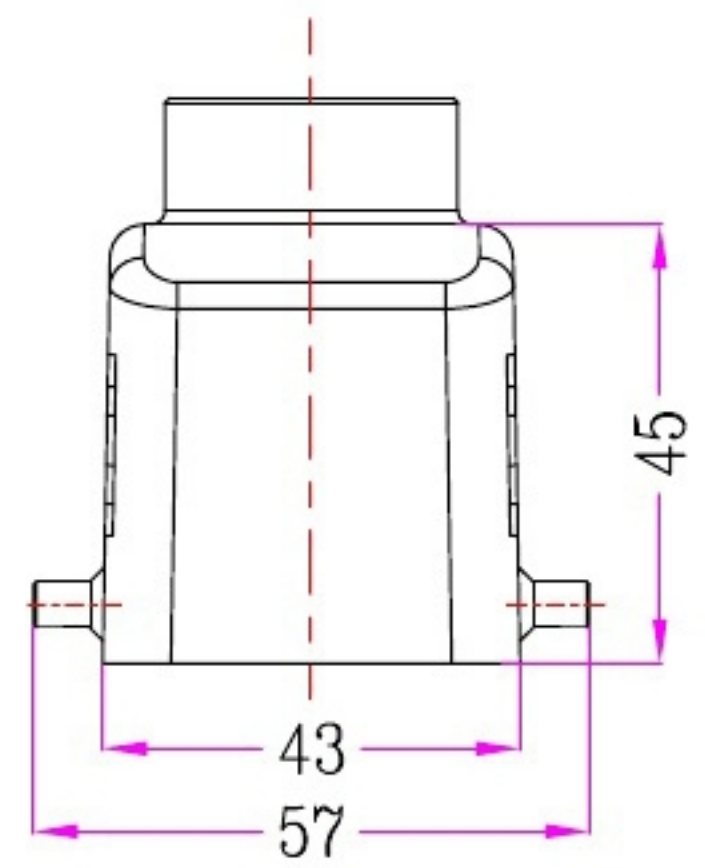

1	2	3	4	5	6	7	8		
Identification	Type name	Part number	Thread(M/PG)	Your Choice	REVISION DATA				
Hoods Top entry	HZW-HV10B-TK-4g-M20	91 502 010 020	M20		SYM	ECN	DESCRIPTION	DATE	APPROVED
	HZW-HV10B-TK-4g-M25	91 502 010 025	M25						
	HZW-HV10B-TK-4g-PG16	91 502 010 016	PG16						

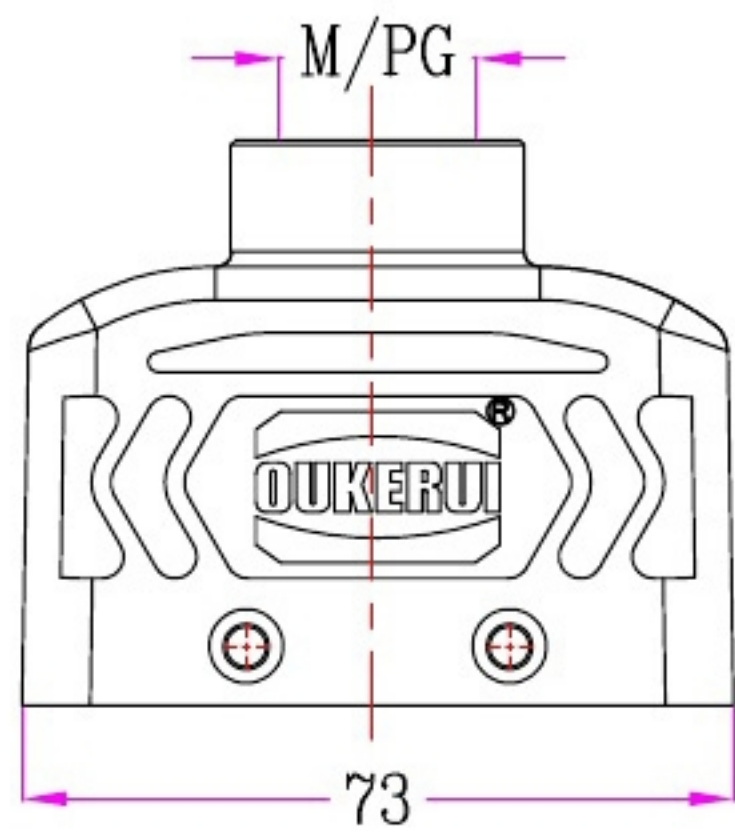

	SIGNATURE	DATE	Units	mm	 宁波欧科瑞连接器有限公司 NINGBO OKERUI CONNECTOR CO.,LTD.		
DRAW			Size	A4	TYPE NAME	HZW-HV10B-TK-4g-M/PG	
DESIGN			Scale		Part number	91 502 010 XXX	REV
CHECK			Sheet	1/1	File path	OKR.10V.H10VM	A0
APPROVE			Proj.	