

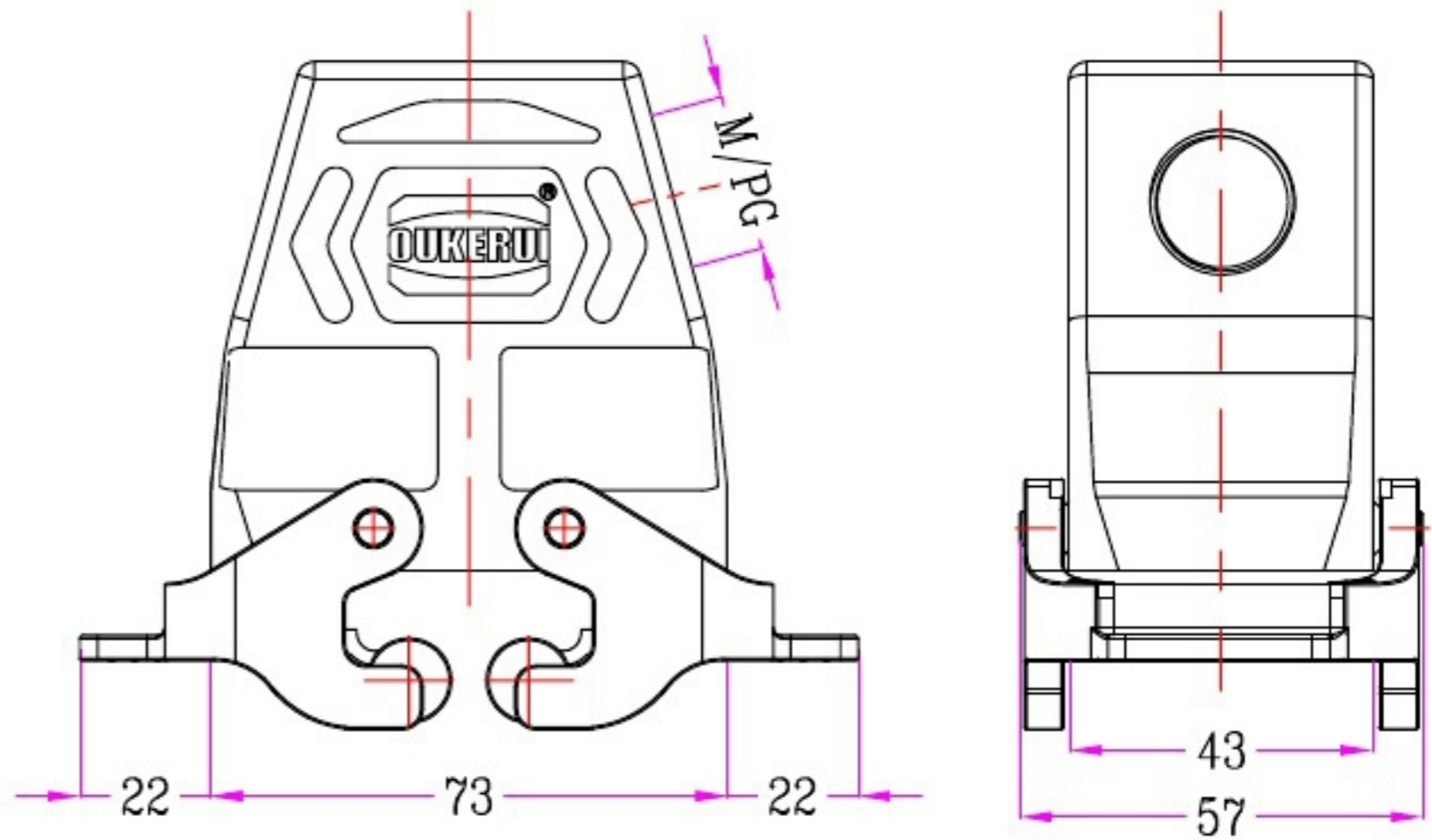

1	2	3	4	5	6	7	8			
Identification	Type name	Part number	Thread(M/PG)	Lever type	Your Choice	REVISION DATA				
Hoods Side entry High structure	HZW-HV10B-SKH-2PL/R-M25	93 512 010 125	M25	Plastic and Metal		SYM	ECN	DESCRIPTION	DATE	APPROVED
	HZW-HV10B-SKH-2PL/R-M32	93 512 010 132	M32	Plastic and Metal						
	HZW-HV10B-SKH-2PL/R-PG21	93 512 010 121	PG21	Plastic and Metal						
	HZW-HV10B-SKH-2PL/R-PG29	93 512 010 129	PG29	Plastic and Metal						
	HZW-HV10B-SKH-2PL/M-M25	93 512 010 125	M25	Metal						
	HZW-HV10B-SKH-2PL/M-M32	93 512 010 132	M32	Metal						
	HZW-HV10B-SKH-2PL/M-PG21	93 512 010 121	PG21	Metal						
	HZW-HV10B-SKH-2PL/M-PG29	93 512 010 129	PG29	Metal						



	SIGNATURE	DATE	Units	mm	 宁波欧科瑞连接器有限公司 NINGBO OKERUI CONNECTOR CO.,LTD.	
DRAW			Size	A4	TYPE NAME	HZW-HV10B-SKH-2PL/RM-M/PG
DESIGN			Scale		Part number	93 512 010 XXX REV
CHECK			Sheet	1/1	File path	OKR.10V.H10VM A0
APPROVE			Proj.	