

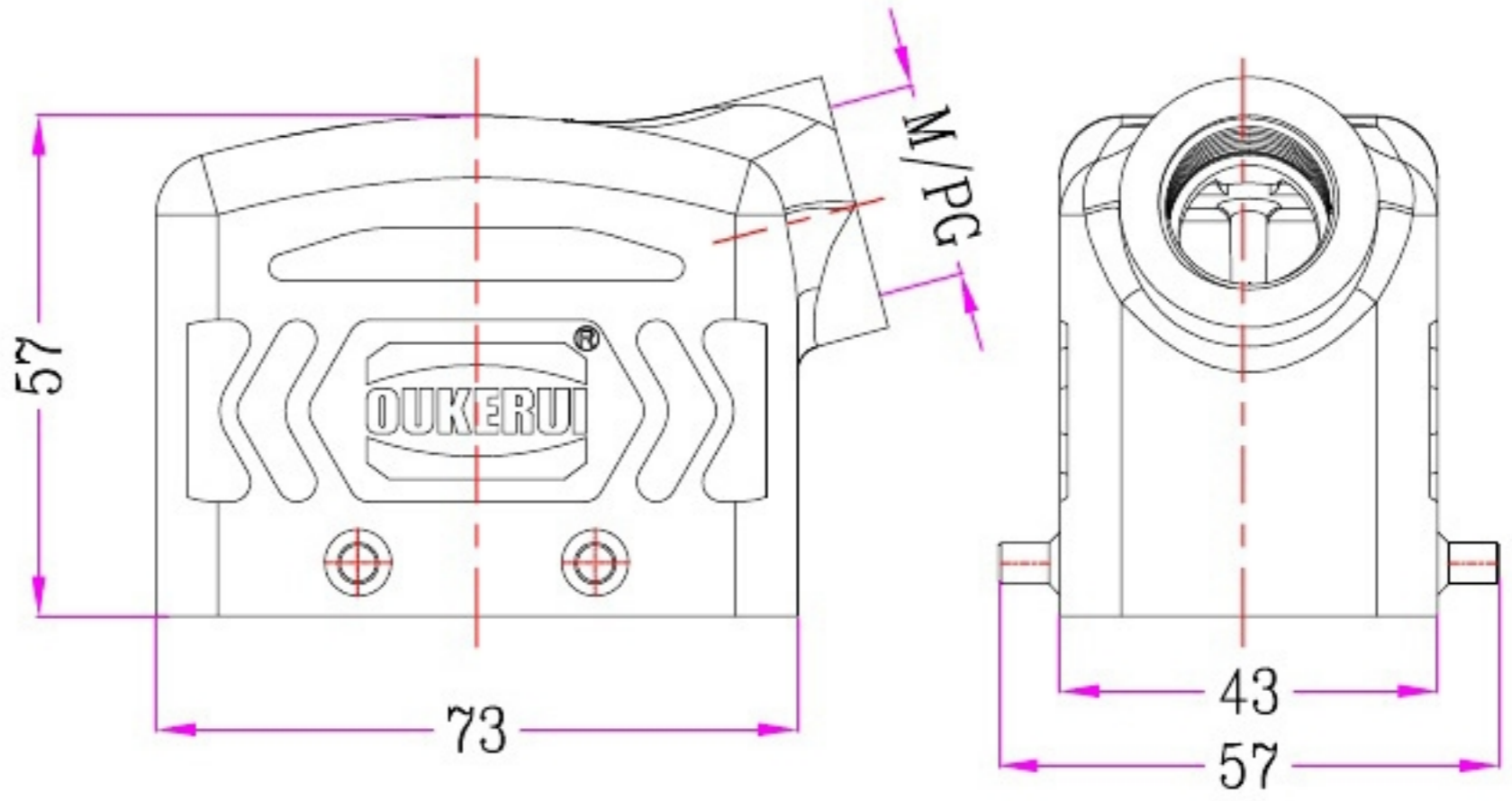

1	2		3	4	5	6		7	8	
Identification	Type name		Part number	Thread(M/PG)	Your Choice	REVISION DATA				
Hoods	HZW-HV10B-SK-4g-M20		91 512 010 020	M20		SYM	ECN	DESCRIPTION	DATE	APPROVED
Side entry	HZW-HV10B-SK-4g-M25		91 512 010 025	M25						
	HZW-HV10B-SK-4g-PG16		91 512 010 016	PG16						



	SIGNATURE	DATE	Units	mm	 宁波欧科瑞连接器有限公司 NINGBO OKERUI CONNECTOR CO.,LTD.	
DRAW			Size	A4	TYPE NAME	HZW-HV10B-SK-4g-M/PG
DESIGN			Scale		Part number	91 512 010 XXX REV
CHECK			Sheet	1/1	File path	OKR.10V.H10VM A0
APPROVE			Proj.	