

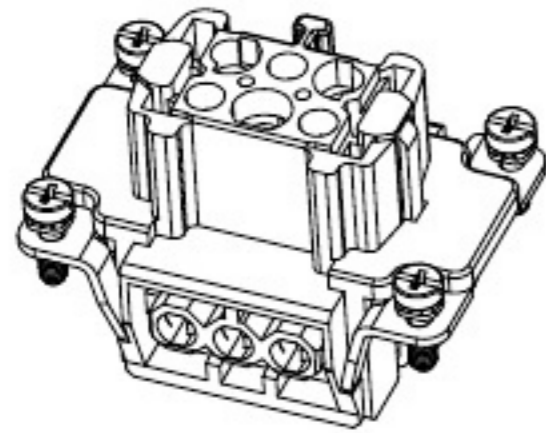

SYMBOL		REVISION DATA		
SYM	ECN	DESCRIPTION	DATE	APPROVED

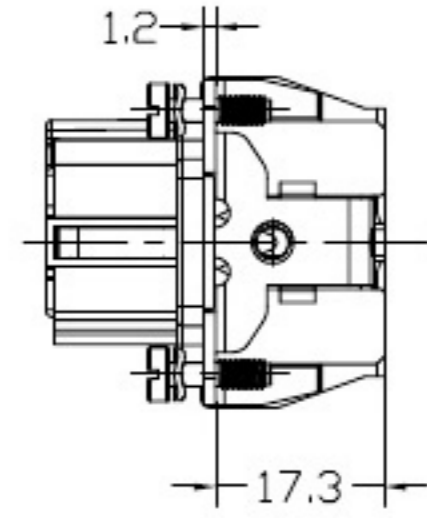
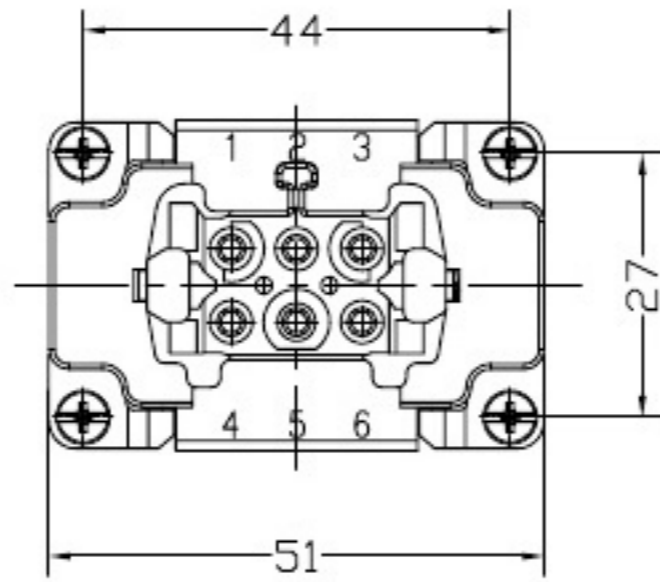
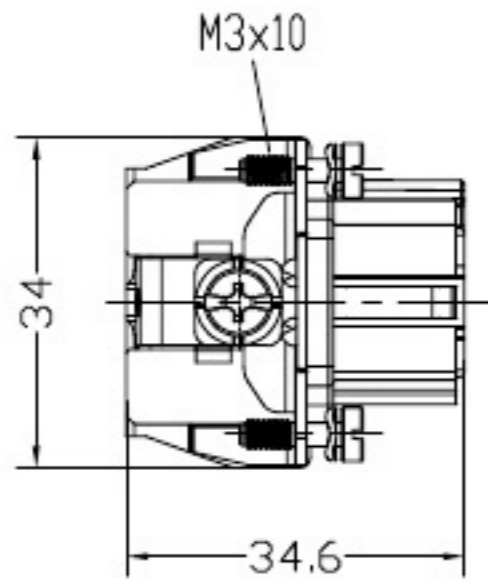
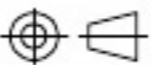

	SIGNATURE	DATE	Units	mm	 宁波欧科瑞连接器有限公司 NINGBO OKERUI CONNECTOR CO.,LTD.	
DRAW			Size	A4		
DESIGN			Scale	1:1	PART NAME	HZW-HE-006-F
CHECK			Sheet	1/1	Drawing NO.	61 206 006 262 REV
APPROVE			Proj.		File path	OKR. HEP. 006F A0