

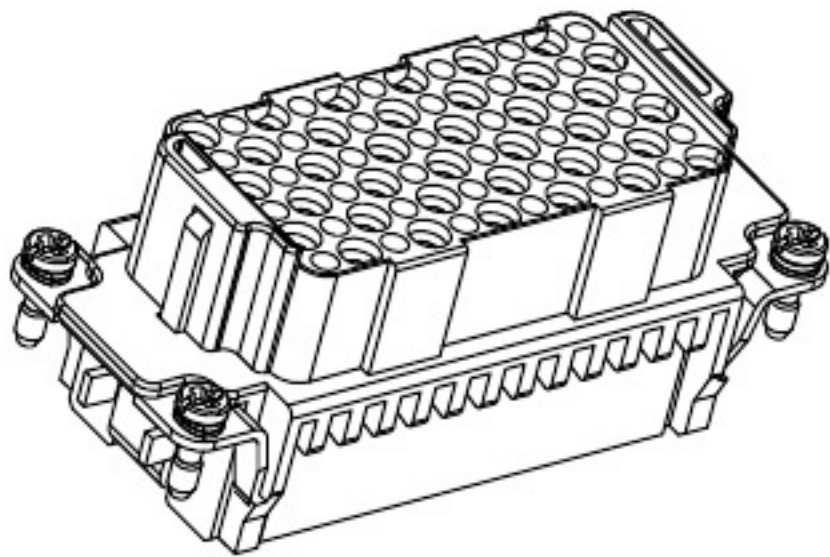

REVISION DATA				
SYM	ECN	DESCRIPTION	DATE	APPROVED

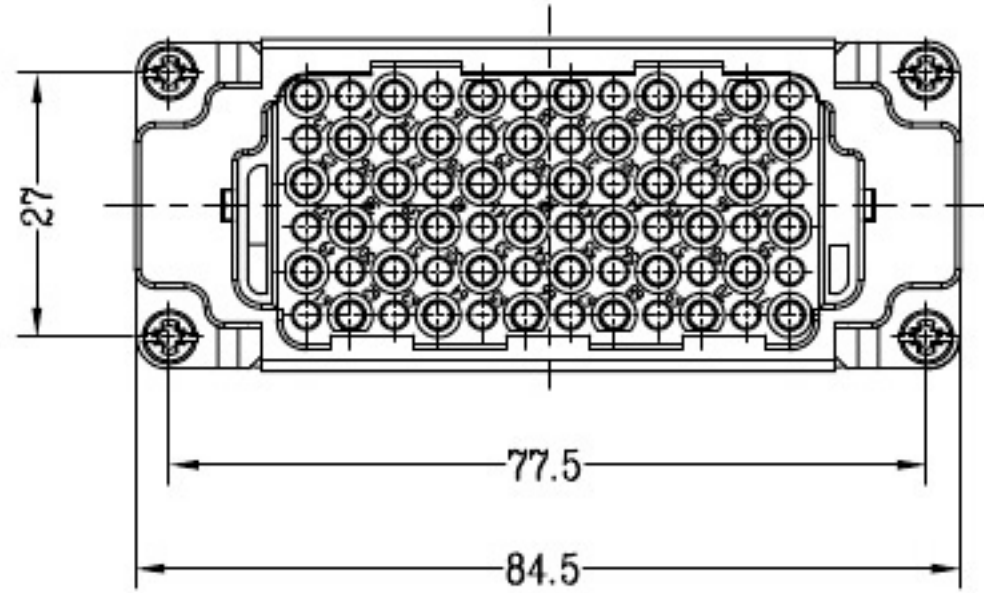
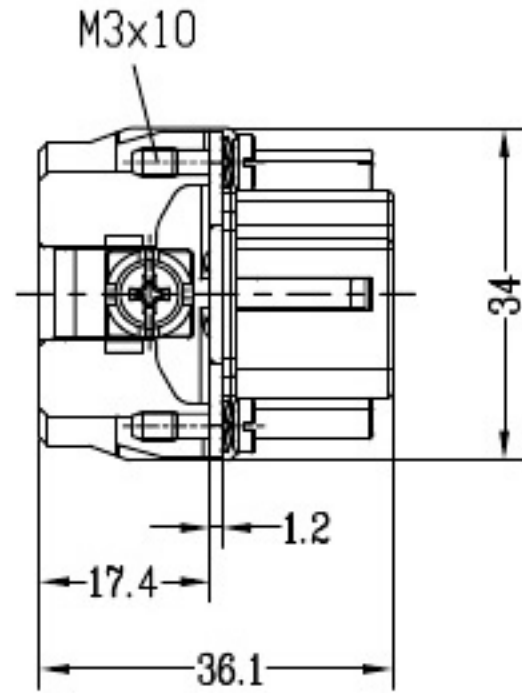

	SIGNATURE	DATE	Units	mm	 宁波欧科瑞连接器有限公司 NINGBO OKERUI CONNECTOR CO.,LTD.	
DRAW			Size	A4	PART NAME	HZW-HDD-072-FC
DESIGN			Scale	1:1	Drawing NO.	61 244 072 422 REV
CHECK			Sheet	1/1	File path	OKR.DDP.072FC A0
APPROVE			Proj.	