

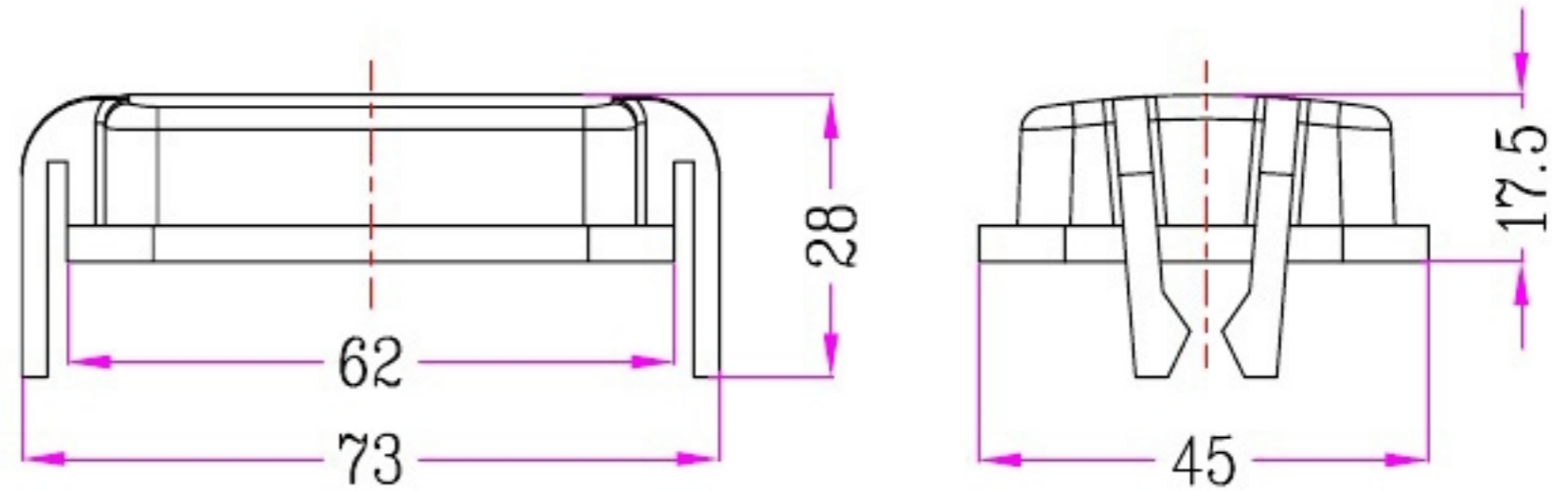
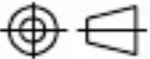

REVISION DATA				
SYM	ECN	DESCRIPTION	DATE	APPROVED



	SIGNATURE	DATE	Units	mm	 宁波欧科瑞连接器有限公司 NINGBO OKERUI CONNECTOR CO.,LTD.	
DRAW			Size	A4		
DESIGN			Scale		TYPE NAME	HZW-H6B-CV-2C
CHECK			Sheet	1/1	Part number	81 301 006 111 REV
APPROVE			Proj.		File path	OKR.06B.H06BV A0