

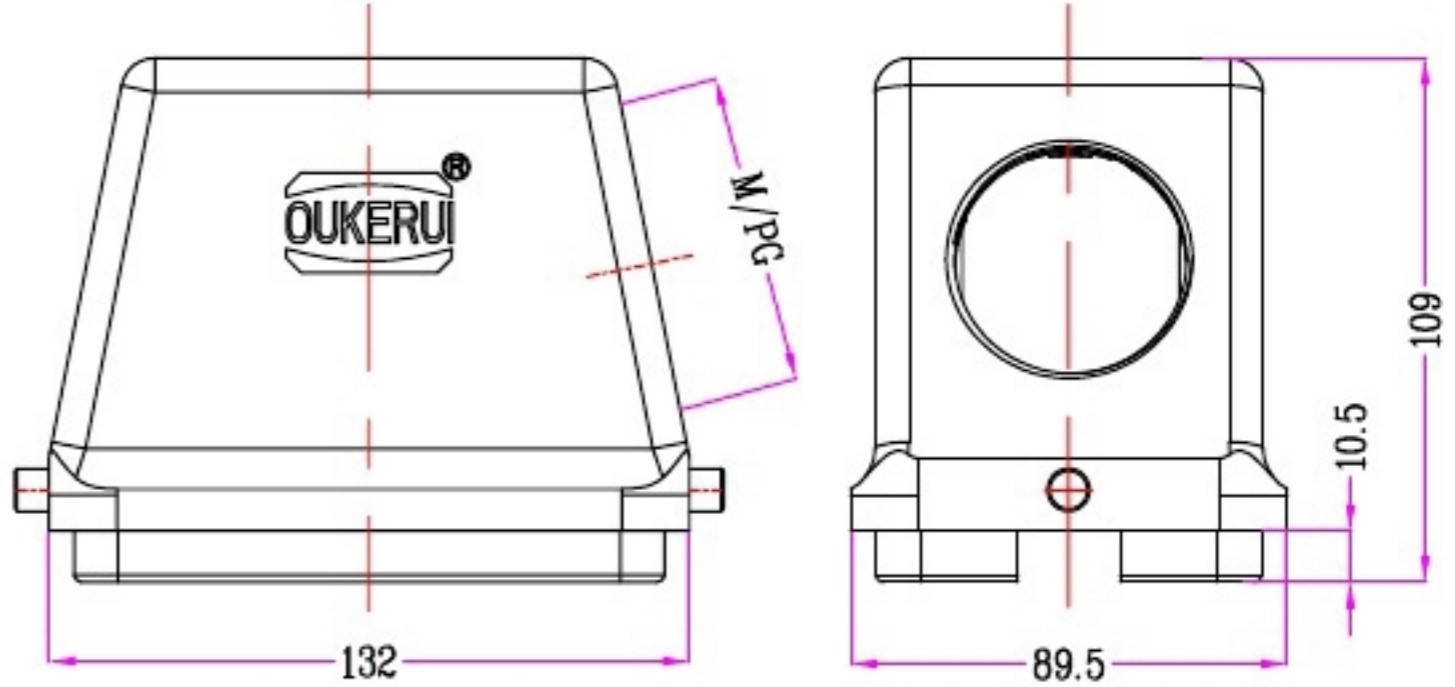

1	2	3	4	5	6	7	8		
Identification	Type name	Part number	Thread(M/PG)	Your Choice	REVISION DATA				
Hoods Side entry	HZW-H48B-SK-2g-M32	81 316 048 132	M32		SYM	ECN	DESCRIPTION	DATE	APPROVED
	HZW-H48B-SK-2g-M40	81 316 048 140	M40						
	HZW-H48B-SK-2g-M50	81 316 048 150	M50						
	HZW-H48B-SK-2g-PG29	81 316 048 129	PG29						
	HZW-H48B-SK-2g-PG36	81 316 048 136	PG36						
	HZW-H48B-SK-2g-PG42	81 316 048 142	PG42						



	SIGNATURE	DATE	Units	mm	 宁波欧科瑞连接器有限公司 NINGBO OKERUI CONNECTOR CO.,LTD.		
DRAW			Size	A4	TYPE NAME HZW-H48B-SK-2g-M/PG		
DESIGN			Scale		Part number	81 316 048 XXX	REV
CHECK			Sheet	1/1	File path	OKR. 48B. H48BM	A0
APPROVE			Proj.	