

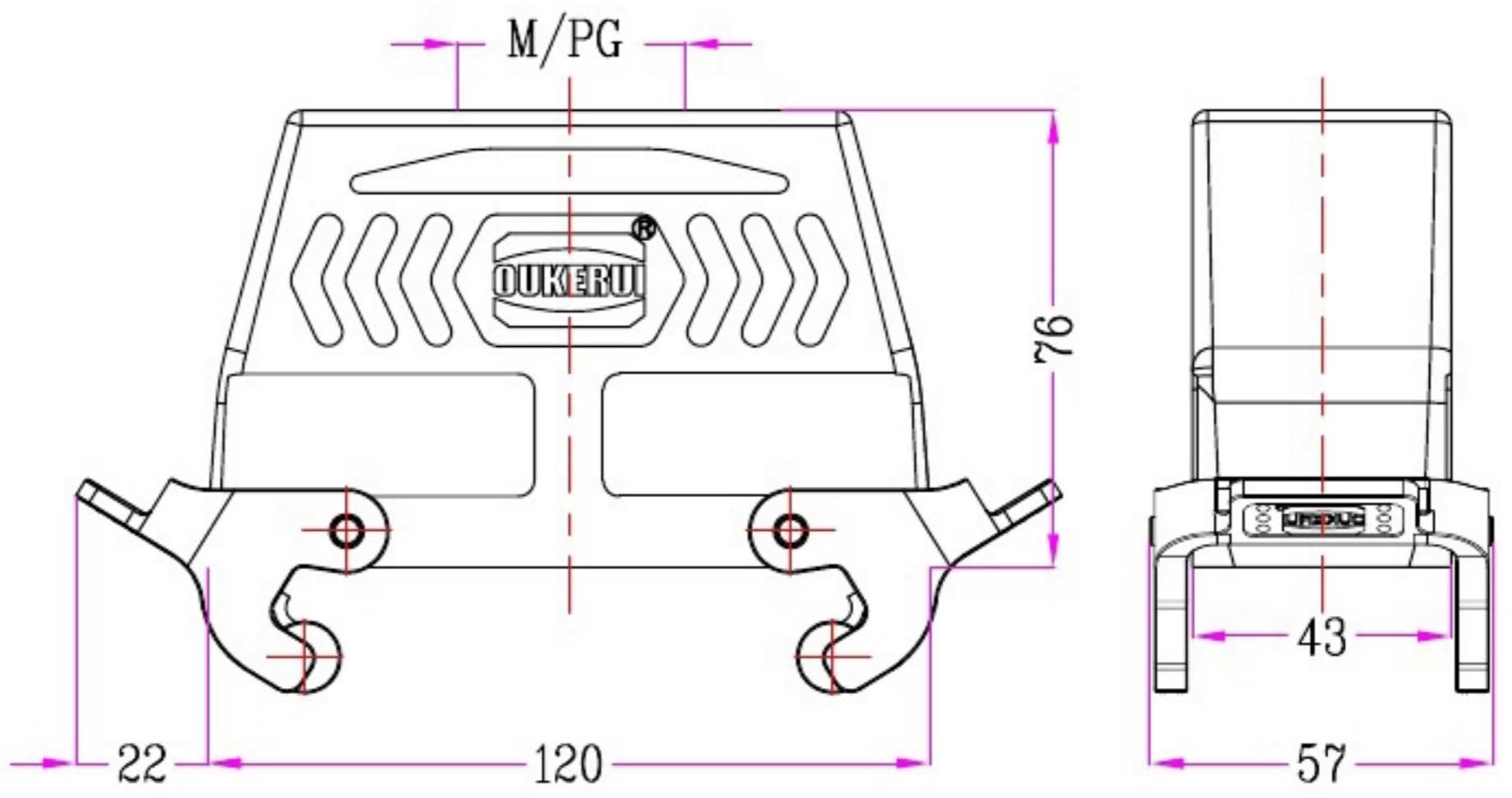

1	2	3	4	5	6	7	8			
Identification	Type name	Part number	Thread(M/PG)	Lever type	Your Choice	REVISION DATA				
Hoods Top entry High structure	HZW-H24B-TKH-2PL/R-M32	83 304 024 132	M32	Plastic and Metal		SYM	ECN	DESCRIPTION	DATE	APPROVED
	HZW-H24B-TKH-2PL/R-M40	83 304 024 140	M40	Plastic and Metal						
	HZW-H24B-TKH-2PL/R-PG21	83 304 024 121	PG21	Plastic and Metal						
	HZW-H24B-TKH-2PL/R-PG29	83 304 024 129	PG29	Plastic and Metal						
	HZW-H24B-TKH-2PL/M-M32	83 304 024 132	M32	Metal						
	HZW-H24B-TKH-2PL/M-M40	83 304 024 140	M40	Metal						
	HZW-H24B-TKH-2PL/M-PG21	83 304 024 121	PG21	Metal						
	HZW-H24B-TKH-2PL/M-PG29	83 304 024 129	PG29	Metal						



	SIGNATURE	DATE	Units	mm	 宁波欧科瑞连接器有限公司 NINGBO OKERUI CONNECTOR CO.,LTD.	
DRAW			Size	A4	TYPE NAME	HZW-H24B-TKH-2PL/RM-M/PG
DESIGN			Scale		Part number	83 304 024 XXX REV
CHECK			Sheet	1/1	File path	OKR. 24B. H24BM A0
APPROVE			Proj.	