

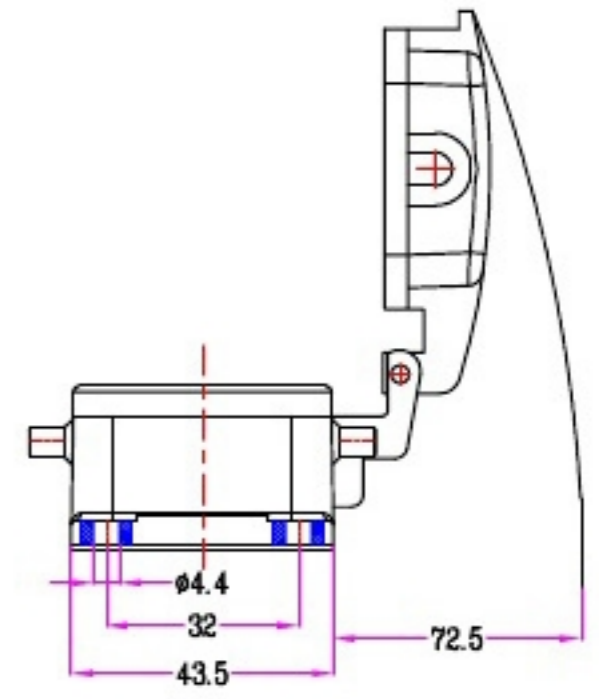

1	2	3	4	5
Identification	Type name	Part number	Thread(M/PG)	Lever type
Housings Bulkhead mounting With metal cover	HZW-H24B-ST-4g-MCV	81 304 024 103		Your Choice

REVISION DATA				
SYM	ECN	DESCRIPTION	DATE	APPROVED

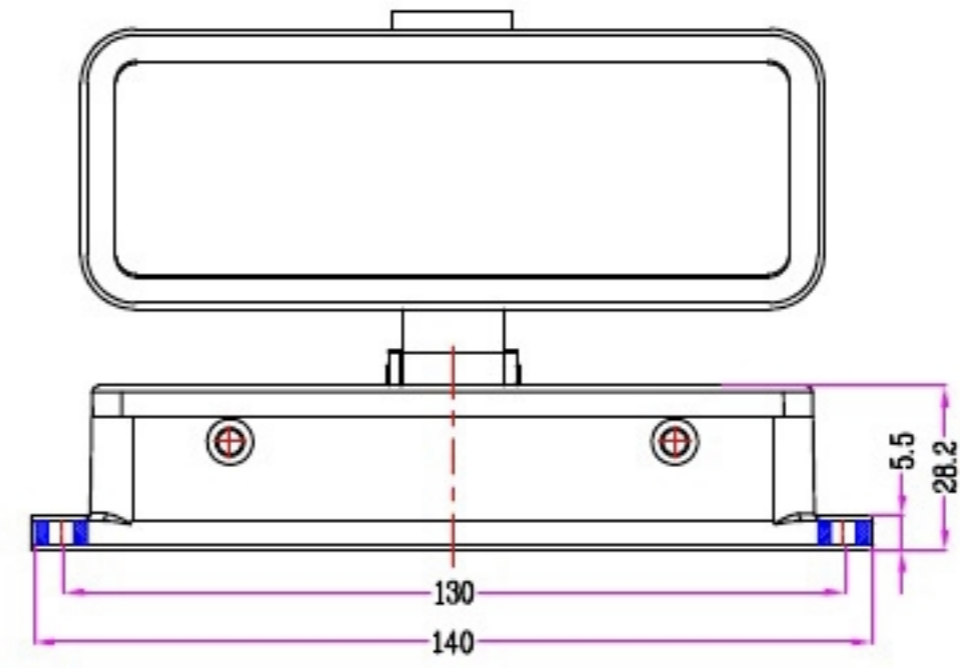
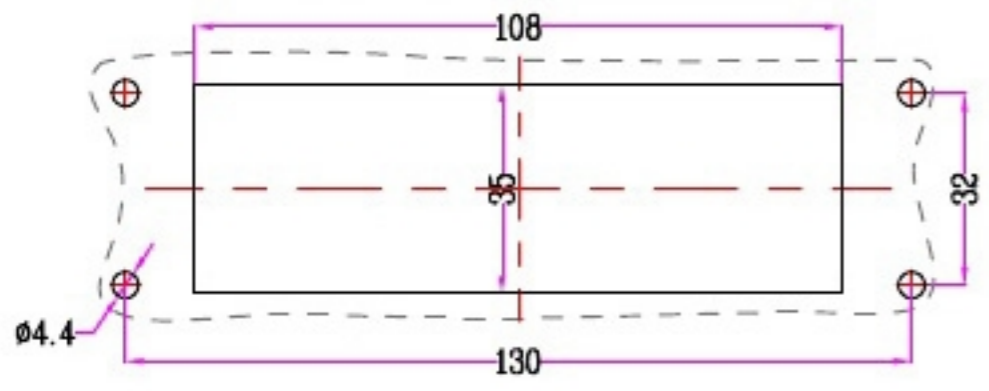

Bulkhead mounting  
Panel cut out

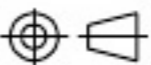

	SIGNATURE	DATE	Units	mm	 宁波欧科瑞连接器有限公司 NINGBO OKERUI CONNECTOR CO.,LTD.		
DRAW			Size	A4			
DESIGN			Scale		TYPE NAME	HZW-H24B-ST-4g-MCV	
CHECK			Sheet	1/1	Part number	81 304 024 103	REV
APPROVE			Proj.		File path	OKR. 24B. H24BL	A0