

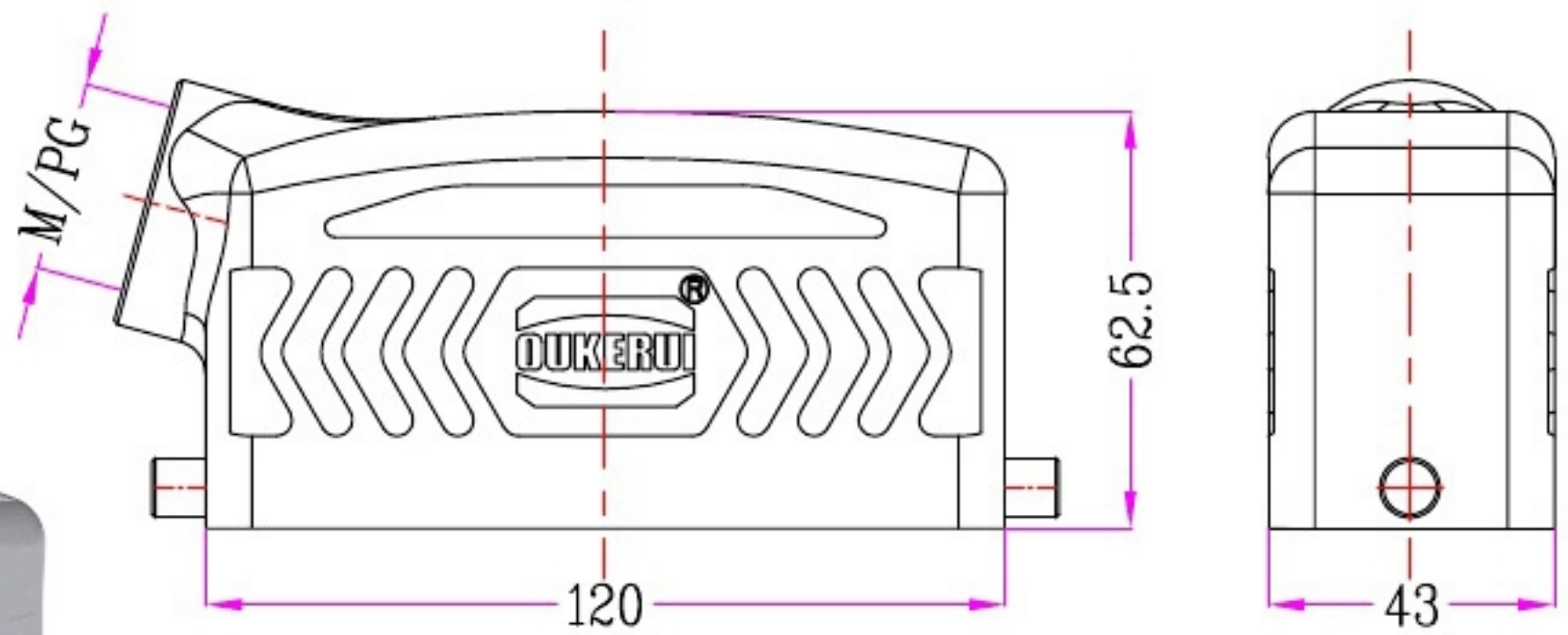

1	2	3	4	5	6	7	8		
Identification	Type name	Part number	Thread(M/PG)	Your Choice	REVISION DATA				
Hoods Side entry	HZW-H24B-SK-2g-M25	82 314 024 025	M25		SYM	ECN	DESCRIPTION	DATE	APPROVED
	HZW-H24B-SK-2g-M32	82 314 024 032	M32						
	HZW-H24B-SK-2g-PG21	82 314 024 021	PG21						



	SIGNATURE	DATE	Units	mm	 宁波欧科瑞连接器有限公司 NINGBO OKERUI CONNECTOR CO.,LTD.		
DRAW			Size	A4	TYPE NAME	HZW-H24B-SK-2g-M/PG	
DESIGN			Scale		Part number	82 314 024 XXX	REV
CHECK			Sheet	1/1	File path	OKR. 24B. H24BM	A0
APPROVE			Proj.	