

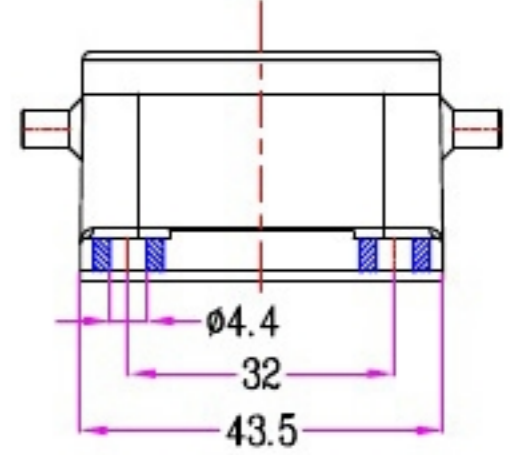

1	2	3	4	5
Identification	Type name	Part number	Thread(M/PG)	Lever type
Housings	HZW-H16B-ST-4g	81 303 016 100		
Bulkhead mounting				Your Choice

REVISION DATA				
SYM	ECN	DESCRIPTION	DATE	APPROVED

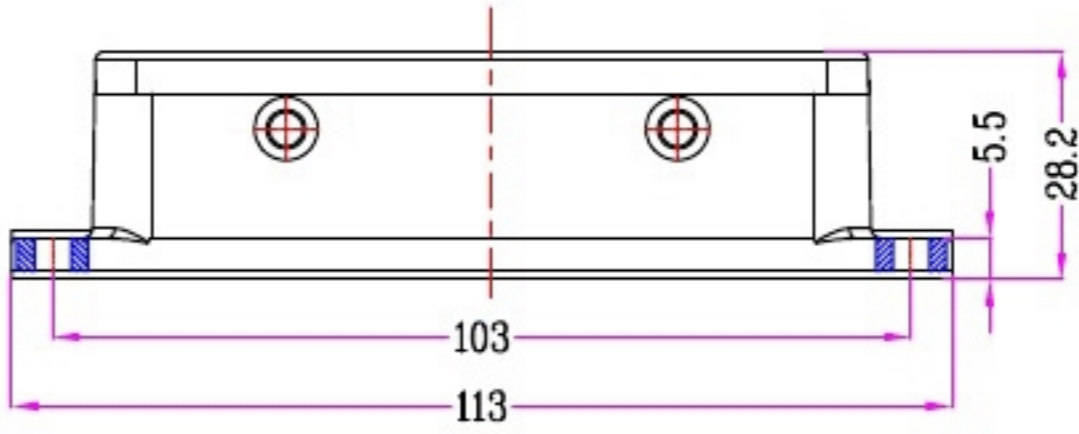
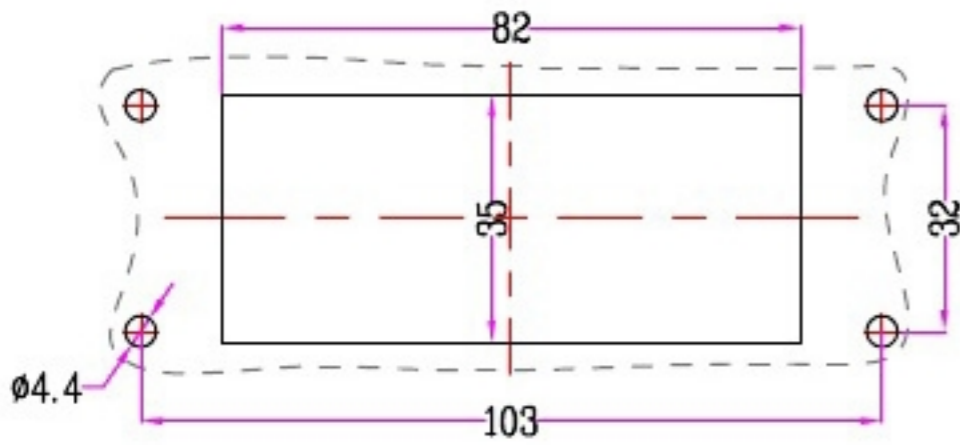

Bulkhead mounting
Panel cut out

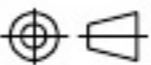

	SIGNATURE	DATE	Units	mm	 宁波欧科瑞连接器有限公司 NINGBO OKERUI CONNECTOR CO.,LTD.		
DRAW			Size	A4			
DESIGN			Scale		TYPE NAME	HZW-H16B-ST-4g	
CHECK			Sheet	1/1	Part number	81 303 016 100	REV
APPROVE			Proj.		File path	OKR.16B.H16BL	A0