

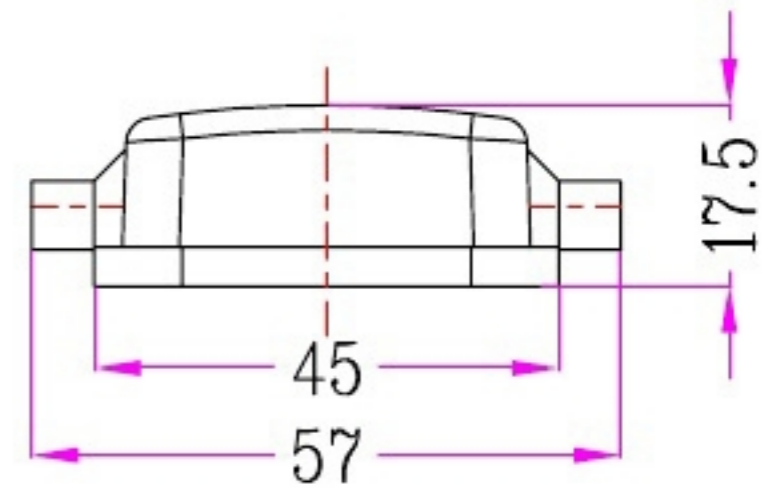

REVISION DATA				
SYM	ECN	DESCRIPTION	DATE	APPROVED

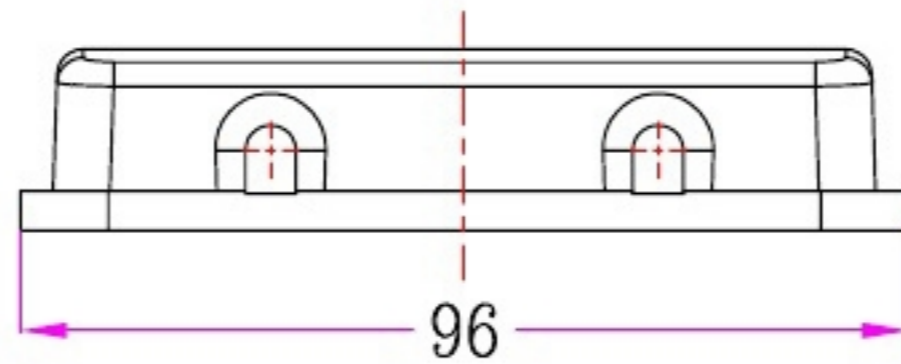
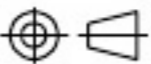

	SIGNATURE	DATE	Units	mm	 宁波欧科瑞连接器有限公司 NINGBO OKERUI CONNECTOR CO.,LTD.	
DRAW			Size	A4		
DESIGN			Scale		TYPE NAME	HZW-H16B-CV-4g
CHECK			Sheet	1/1	Part number	81 303 016 222 REV
APPROVE			Proj.		File path	OKR.16B.H16BV A0