

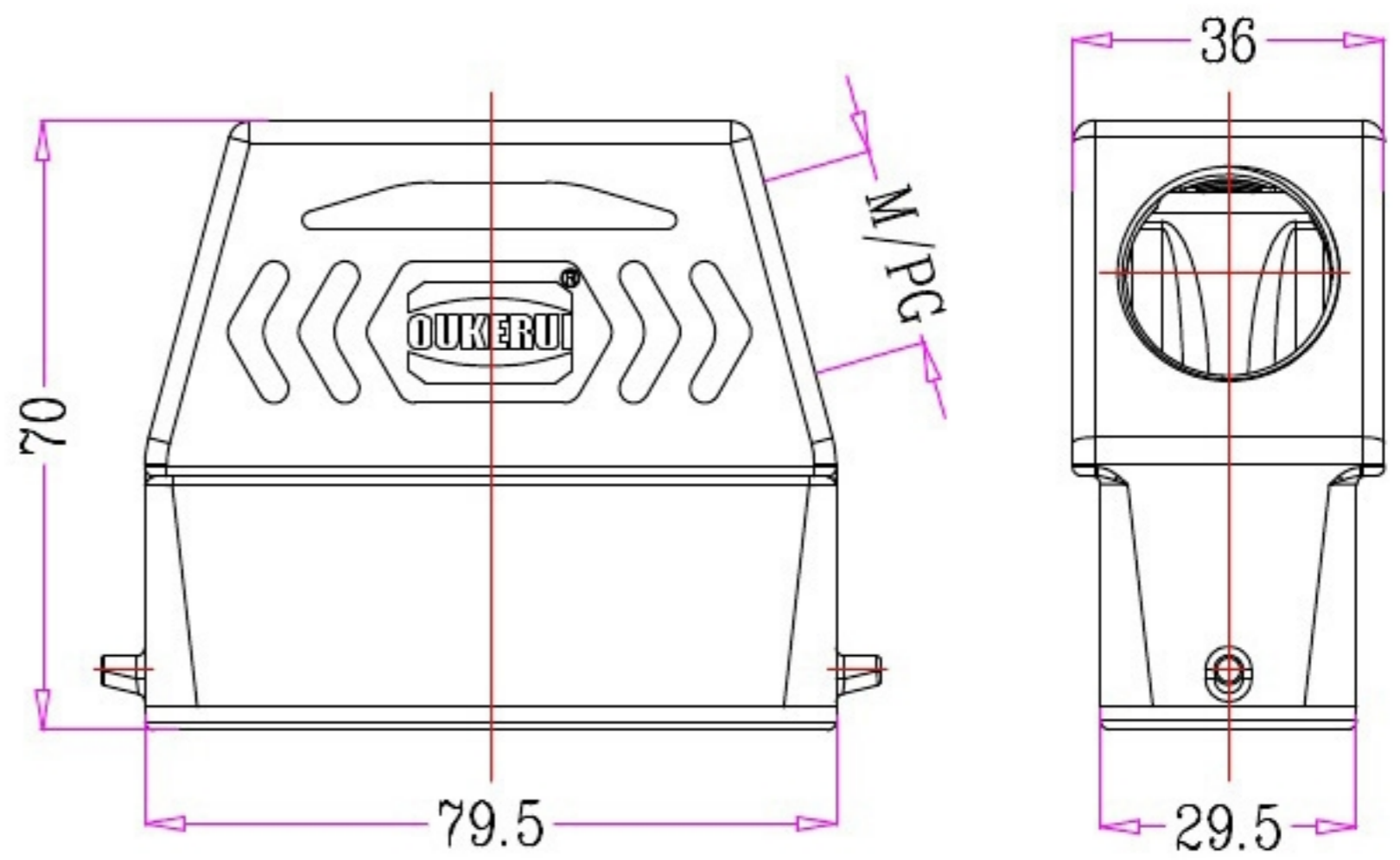

1	2	3	4	5
Identification	Type name	Part number	Thread (M/PG)	Your Choice
Hoods Top entry High structure	HZW-H16A-SKH-2g-M25	81 262 016 125	M25	
	HZW-H16A-SKH-2g-PG16	81 262 016 116	PG16	
	HZW-H16A-SKH-2g-PG21	81 262 016 121	PG21	

REVISION DATA				
6	7	8	9	10
SYM	ECN	DESCRIPTION	DATE	APPROVED

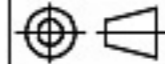

	SIGNATURE	DATE	Units	mm	 宁波欧科瑞连接器有限公司 NINGBO OUKERUI CONNECTOR CO.,LTD.
DRAW			Size	A4	
DESIGN			Scale	1:1	TYPE NAME HZW-H16A-SKH-2g-M/PG
CHECK			Sheet	1/1	Part number 81 262 016 XXX REV
APPROVE			Proj.		File path OKR_16A_H16AM AO